

PRK

INDOOR PORTABLE KIOSK

10-HOUR

WIRELESS BATTERY LIFE



EASY TO MOVE



BATTERY-POWERED



PRODUCT DISPLAY

BATTERY PLAYTIME **10** hrs

HANDLE



ELECTRONIC INTERFACE

1. POWER
2. CHARGING INTERFACE
3. HDMI
4. USB
5. USB

WIFI BATTERY STATUS

AIR OUTLET



LITHIUM BATTERY

1080p
FULLHD

FULL HD SCREEN



BATTERY-POWERED



EASY TO MOVE



CMS CLOUD CONTROL



ANDROID OS

INDUSTRIAL CASTERS

Split Screen	Remote Control	7Days 24Hours Running	Anti-theft Lock	Miracast	WIFI	Heat Dissipation	Multi-signal	Remote Monitoring	Customized

1. IPS PANEL



Industrial grade IPS technology accurately displays image quality and colour depth with no fall-off in colour accuracy.

2. 4K DISPLAY



The pixel density or quantity of in each inch of this 4k new format the greater the pixel density is, the bigger the image's detail will be. Can bring the user more lifelike visual experience.

3. WIDE VIEWING ANGLE



These displays provide fantastic image quality with a remarkable viewing angle of 178° in both landscape and portrait.

4. SCROLLING TEXT



SALE NOW ON-30% OFF ALL CLOTHES-END TONIGHT-SALE NOW ON-30% OFF ALL

You can display a "ticker tapy" style scrolling text message along the bottom of the screen.

5. BUILD-IN REPLACEABLE LITHIUM BATTERY



NO WIRING, Battery play time 10 Hours

6. 10 POINT PCAP / IR TOUCH

10
Touch Points



Manipulate images, zoom in an out as well as perform many other touch gestures; Multiple users interacting with the screen at one time.

7. INTEGRATED SPEAKERS



Integrated with two stereo speakers for audio element requirement.

8. FREE SCHEDULING SOFTWARE

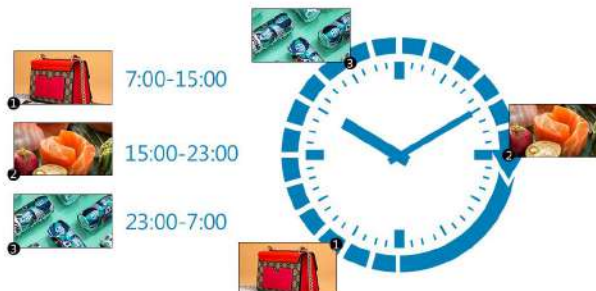

Playlist can be scheduled for displaying different content at different times of the day.

9. POWER TIMER



The screen can be set to automatic daily or weekly timing switches on and off.

10. 24/7 USAGE



The industrial grade panels are able to be in constant use 24/7 for over 60,000 hours.

11. ANDROID OR WINDOWS OS

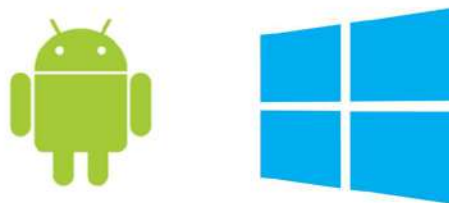

Built-in Android 7.1 operating system and Windows 10 operating system options. You can also use your media player if required.

12. NETWORK REMOTE CONTROL



LAN, Wi-Fi, 4G network connection are available. The playlist can be remotely updated over the internet.

APPLICATION

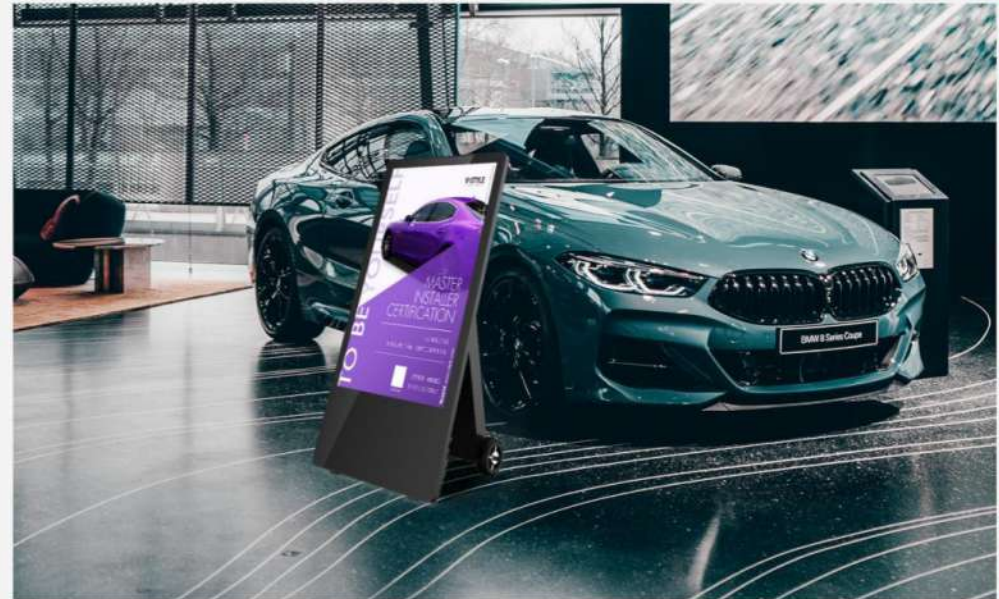

OUR ADVANTAGE



11+ YEARS
OF EXPERIENCE



OEM & ODM
SERVICE



STRICT QUALITY
MANAGEMENT



R & D AND
PATENTED PRODUCTS



CE, FCC, ROHS
CERTIFICATION,



INTEGRATED
SERVICES

SIZE 43"

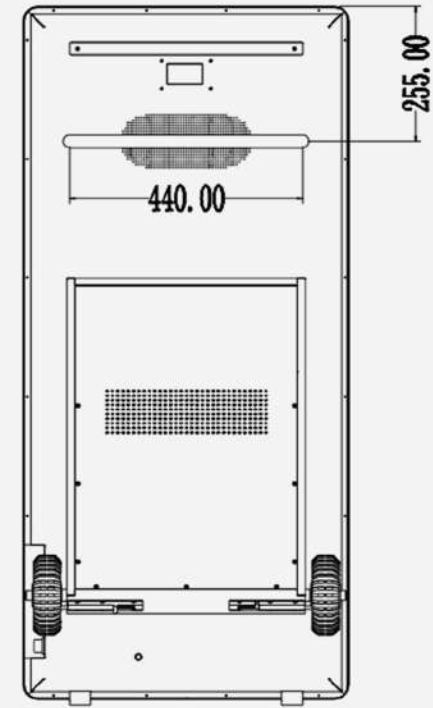
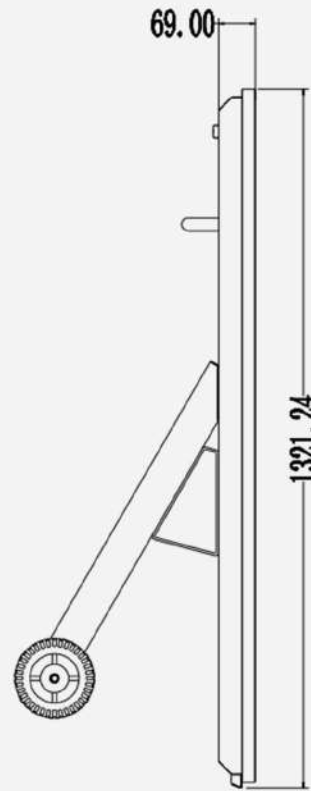
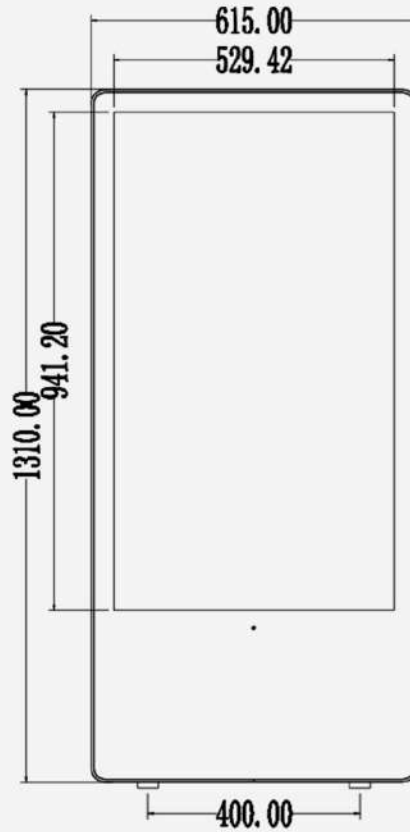

OTHER AVAILABLE SIZES:
32" 43" 49" 55"

CONTENT
MANAGEMENT

DEVICE
MANAGEMENT

REMOTE
CONTROL

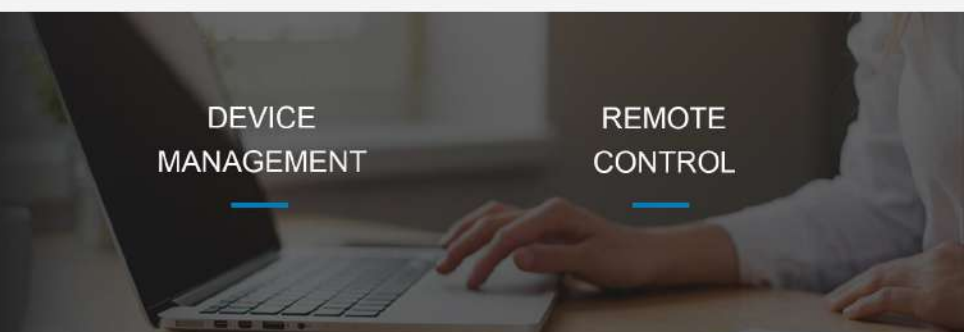

PACKING METHOD



- ① CARTON BOX
- ② WOODEN CASE

- ① FLIGHT CASE

SPECIFICATION

ITEM	DETAILS	TECHNICAL PARAMETERS		
Hardware data	Size	32inch	43inch	49inch
	Display area (mm)	698.4*392.85	941.1*529.4	1073.8*604
	Referent dimension(H*W*T mm)		1321*615*69	
	Resolution		1920*1080 / 3840*2160	
	Brightness		350 cd/m ² / 500 cd/m ² / 700 cd/m ² / 1000 cd/m ²	
	Viewing angle		178° (H) / 178° (V)	
	Contrast ratio		1400:1	
	Shell material		aluminum profile,metal plate,tempered safety glass	
Power supply	Spearker		2*8Ω5W	
	Switch power		110-240VAC@ 50/60Hz	
Power consumption	Max Power consumption	40W	55W	60W

ITEM	DETAILS	TECHNICAL PARAMETERS
Android version	Motherboard	RK3288/ RK 3399
	CPU	Cores:4; Basic frequency:1.8 GHz; Cortex A17 / Dual Cortex-A72 big core+quad Cortex-A53 small core 64-bit CPU
	Operating System	Android 5.1/ 7.1
	Graphics	Integrated GPU ARM Mali-T764 / Quad core Arm mali-T860Mp4
	Memory	2G
	Storage	16G
	RJ45 LAN interface	100M/1000M
	USB	4 USB 2.0 / 2 USB 3.0
	Player Software	content management system
	Audio support	Intergrated
	Output interface	HDMI *1
	Windows version	Motherboard
CPU		Intel i5 ≥6th generation(i3 & i7 for option)
Operating System		Windows 10 Pro
Graphics		Intel HD Graphics
Memory		4G RAM
Storage		120G SSD
RJ45 LAN interface		100M/1000M
USB		USB*1, SD card*1
Player Software		To be specified by the client
Output interface		HDMI*1, VGA*1

ITEM	DETAILS	TECHNICAL PARAMETERS
Standalone version	Motherboard	SX-260
	CPU	HD video decoding chip
	Operating System	uCOS
	Memory	DDR 128MB
	Storage	NAND Flash 16G
	Video format	MPEG1, MPEG2, MPEG4, H264, WMV
	USB	USB*1, SD card*1
Driver board version	Input interface	HDMI*1,USB*1
	USB	none
	Audio support	PC audio, earphone input
Application Environment	input interface	HDMI*1,VGA*1,DVI*1 / HDMI*1,DVI*1,VGA*1,DP*1
	Operating temperature	0°C ~ +40°C
	Storage temperature	-20°C ~ +60°C
	Humidity	10-80% RH Non-condensing
Options	WiFi access point	Yes
	Cellular router	3G or 4G
	Touchscreen	capacitive touch
	LED backlit company logo	Yes



GLOBAL 7X24 SERVICE



REMOTE TECHNICAL
SUPPORT



SUPPORT CUSTOMER'S
IMPORTANT ACTIVITIES



FREE TECHNICAL
TRAINING



VISIT VIP CUSTOMERS
REGULARLY



1 YEARS WARRANTY